



RMDR (Reciprocal Mixing Dynamic Range) of 110 dB* (at 2 kHz)

Independent Dual Receivers Receive Two Bands Simultaneously

Superior Transmit Phase Noise Characteristics

DIGI-SEL Preselector for Main and Sub Bands

High-Speed, High-Resolution Real-time Spectrum Scope

Touch Screen and Multi-Dial Knob for Smooth Operation

DVI-D Digital Connector for External Display Connection

* At a 2 kHz offset frequency. Receive frequency: 14.2 MHz Mode: CW, IF BW: 500 Hz

Find 7610 Tech Reports



HF/50 MHz TRANSCEIVER IC-7610

Innovative RF Direct Sampling System Achieves 110 dB* (typ.) RMDR

The RF direct sampling system directly converts the analogue signals to digital signals, and collectively puts the data through FPGA (Field-Programmable Gate Array) processing. The master clock uses a high precision VCXO (Voltage Controlled Crystal Oscillator) which excels in low-noise characteristics. This makes it possible to provide superior receive and transmit performance, extremely low phase noise as well as high RMDR (Reciprocal Mixing Dynamic Range).

* At 2 kHz frequency separation.

RMDR Characteristics

* Receive frequency: 14.2 MHz, MODE: CW, IF BW: 500 Hz

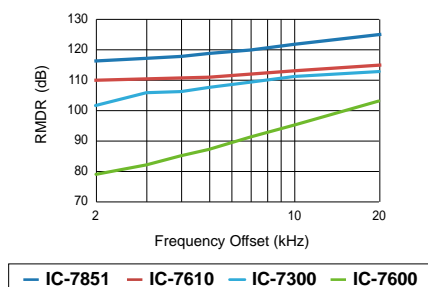

Independent Dual Receivers Receive Two Bands Simultaneously

The dual receivers are ideal for simultaneous monitoring of two bands and two modes. The sub receiver works independently of the main receiver. The optional RC-28 can be used as for main dial and/or the sub dial.

Superior Transmit Phase Noise Characteristics

Breaking with the tradition of mixing a carrier signal with a local oscillator, a Digital-Up-Conversion (DUC) is used to generate required frequencies by sampling in the Digital to Analogue Converter (DAC). The superior Phase Noise characteristics provide high purity transmit signals.

DIGI-SEL Firmly Shuts Out Interfering Signals

Both main and sub receivers are equipped with DIGI-SEL (Digital Preselector) units. The DIGI-SEL has steeper skirt characteristics than normal band-pass filters, so it rejects out of band strong interference, such as broadcast stations, and prevents intermodulation distortion.



DIGI-SEL Unit

High-Speed, High-Resolution Real-time Spectrum Scope

The real-time spectrum scope of the IC-7610 shows main and sub band conditions. It provides class-leading performance in resolution, sweep speed and a 100 dB of dynamic range. The waterfall screen enables you to find weak signals by showing the spectrum change over time. The Scroll mode automatically keeps the operating signal within the scope range.

FFT Scope and Oscilloscope for Audio Observation

The audio scope function shows the FFT scope with waterfall and the oscilloscope of either transmit or receive audio. This function can be used to observe various AF characteristics such as microphone compressor level, filter width, notch filter and receive keying waveform in CW mode.

Touch Screen and Multi-Dial Knob for Smooth Operation

The combination of the touch screen and the multi-dial knob offers quick and smooth operation. When you push the multi-dial knob, menu items are shown on the right side of the display. You can select an item with a touch of the screen, and adjust levels by rotating the multi-dial knob.

Base Station



DVI-D Connector for an External Display Connection

The IC-7610 has a DVI-D connector for an external display. Operating frequency, setting information and spectrum scopes can be observed on a large external display.

High Sound Quality Speaker

The IC-7610's speaker offers comfortable sound quality with flat overall frequency response and loud and intelligible audio of the high-purity received signal. Insulators are placed between the speaker and chassis for preventing vibration noise.

SD Card Slot and USB ports for Data Saving

For multi-operators using one rig, personal settings such as filter settings, Memory channels, and antenna settings, can be saved and loaded using a SD card or USB flash drive. TX Voice memories and RTTY/CW memories on the SD card or USB flash drive can be sent with a touch of a button.

I/Q Signal Output

The I/Q signal output function* enables you to derive digital IF signals from the I/Q output jack.

* The IC-7610 firmware version must be 1.20 or later.

Other Outstanding Features

[Antenna and receiver] • BNC type RX IN/OUT connectors • Built-in automatic antenna tuner • Two types of preamplifiers • 3 dB – 45 dB attenuator • IP+ function improves third order intercept point performance • RTTY demodulator and decoder • Digital twin PBT eliminates interference from adjacent signals

[Transmitter] • TX monitor function • All mode power control • VOX (Voice Operated Transmission) capability • Microphone equalizer and adjustable transmit bandwidth • 50 CTCSS tones

[CW mode] • FPGA-controlled CW keying waveform shaping • Multi-function electronic keyer • CW pitch control from 300 Hz to 900 Hz • Auto repeat function • Contest serial number counter • Normal or short morse number style • Double key jack system • Full

break-in and semi break-in • CW auto tuning • APF (Audio Peak Filter) function adjustable filter position, width, type and AF level

[Operation] • 7-inch wide colour TFT LCD • Simplified IP remote control capability with the optional RS-BA1 Version 2 • Memo pad stores up to 10 operating frequencies and modes • Quick Split function • Quick Dualwatch function • RF gain and squelch control with a knob • RIT and ΔTX variable up to 9.999 kHz • UTC/local clock and timer function • 1 Hz pitch tuning and display • 101 Memory channels • Dial lock function • Adjustable main dial friction • External speaker jacks for main and sub receivers • Multi-function meter • Auto tuning step function • AGC control for fine tuning of the AGC time constant • Screen saver function



Experience
in video



Spectrum scope + Waterfall



FFT scope/Oscilloscope



Touch screen interface

HF/50/70 MHz TRANSCEIVER IC-7300

Class Leading Real-time Spectrum Scope with Waterfall Function

RF Direct Sampling System

Suitable for Starting FT8 Mode

Class Leading Real-time Spectrum Scope with Waterfall Function

The IC-7300's real-time spectrum scope is class-leading in resolution, sweep speed and dynamic range. While listening to received audio, you can check the real-time spectrum scope and quickly move to an intended signal.

Real-time Spectrum Scope Specifications

	IC-7300
Scope system	FFT (Fast Fourier Transform)
Span width	5 kHz–1000 kHz
Resolution *	1 pixel minimum (approximately)
Sweep speed	Max. 30 frames/second (approximately)
Waveform display area (vertical axis)	80 dB
Other functions	Waterfall function, Audio scope function

* Number of pixels shown at the 60 dB level, when receiving a signal.

RF Direct Sampling System

The IC-7300 employs an RF direct sampling system. RF signals are directly converted to digital data and processed in the FPGA (Field-Programmable Gate Array), making it possible to simplify the circuit construction. This system is the new benchmark technology making an epoch in amateur radio.

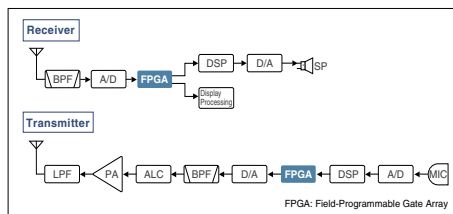

Class Leading RMDR and Phase Noise Characteristics

The IC-7300's RMDR is improved to about 100 dB* (typical value) and Phase Noise characteristics are improved about 20 dB (at 2 kHz frequency separation) compared to the IC-7200. The superior Phase Noise characteristics reduce noise components in both receive and transmit signals.

* At 2 kHz frequency separation (received frequency: 14.2 MHz, MODE: CW, IF BW: 500 Hz)

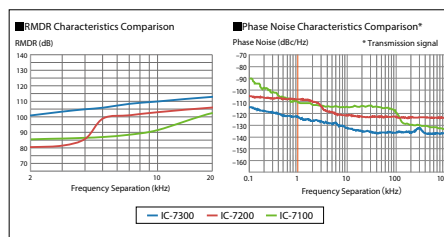

One-Touch FT8 Mode Preset

Preset memory offers smooth FT8 mode operation. You can start FT8 mode operation only by selecting [FT8] from PRESET menu. Up to five preset memories can be stored.

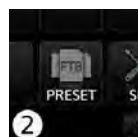

15 Discrete Band-pass Filters

The IC-7300 has 15 discrete RF bandpass filters. The RF signal is only passed through one of the bandpass filters, while any out-of-range signals are rejected. High Q factor coils are used to minimize the loss in the RF band-pass filters.

Superior Signal Quality

The RF direct sampling system is naturally superior at signal linearity and noise immunity by digitally processing the signal from RF to AF. Mathematical frequency conversions within the FPGA drastically improve the signal purity. Thanks to these features, though it is a compact radio, the IC-7300 enjoys exceptionally clear and rich sound which normally can only be expected from a higher class radio.

Large Touch Screen Colour TFT LCD

The large 4.3 inch colour TFT touch LCD offers intuitive operation. Using the software keypad, you can easily set various functions and edit memory contents.

Other Features

- Audio scope function
- Built-in automatic antenna tuner
- Multi-dial knob for smooth operation
- SD card slot for saving data
- New speaker unit design
- HM-219 hand microphone supplied
- A large and effective cooling fan system
- Multi-function meter
- 101 Memory channels (99 regular, 2 scan edges)
- Optional RS-BA1 Version 2 IP remote control software
- "IP+" function improves the third order intercept point (IP3) performance
- CW functions: Full break-in, CW reverse, CW auto tuning
- 70 MHz operation is possible in the European transceiver version

DIGITAL

Terminal Mode
DV Gateway
Access Point Mode



Perfect companion of the IC-7300



Menu screen 1



Menu screen 2

144/430/1200 MHz ALL MODE TRANSCEIVER IC-9700

All Mode, Tri-band Transceiver,
with Built-in 1200 MHz

RF Direct Sampling System

Real-time Spectrum Scope
with Waterfall Display

All Mode, Tri-band Transceiver with Built-in 1200 MHz

The IC-9700 is an all mode Tri-band transceiver, covering 2 m, 70 cm, and 23 cm. In addition to the traditional SSB, AM, FM, CW, and RTTY modes, the transceiver also incorporates D-STAR DV and DD modes. Satellite mode is also built-in!

RF Direct Sampling System

The RF Direct Sampling system, for 144 MHz and 430 MHz, is utilized in the IC-9700. The outcome is that the signal purity is very high, and clear audio can be generated.

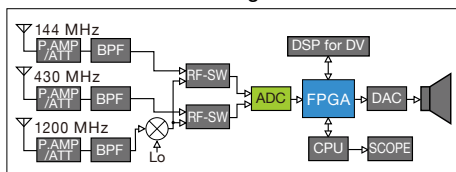

Real-Time Spectrum Scope and Waterfall Display

The IC-9700 has a real-time spectrum scope and waterfall display comparable to an HF high tier transceiver. With the high-speed spectrum scope, you can instantly see the operating band condition. The Scroll mode automatically keeps the operating signal within the scope range.

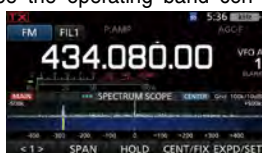

Independent Receiver, Full Duplex Operation

The IC-9700 can simultaneously receive on two different bands, and two different modes. This function can be a significant advantage when participating in contests or searching for weak signals. Furthermore, the IC-9700 is Full Duplex, which enables you to transmit on the main band while receiving on the sub band.

Newly Designed Power Amplifier

The power amplifier outputs stable power with high efficiency (144/430/1200 MHz band: 100/75/10 watts). The cooling system prevents the PA from overheating, even when operating for a long time.

D-STAR Operation Friendly Functions

The IC-9700 has the D-STAR Repeater (DR) function that can be simultaneously used on both the Main and Sub bands to listen to two separate DV signals. Moreover, by using the DD mode, you can browse the Internet through a repeater station.

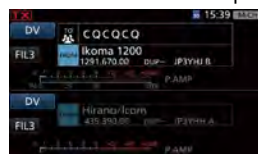

One-Touch FT8 Mode Preset

Preset memory offers smooth FT8 mode operation. You can start FT8 mode operation only by selecting [FT8] from PRESET menu. Up to five preset memories can be stored.

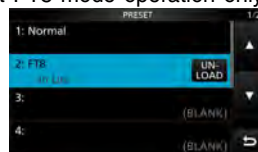

Built-in DV Gateway Functions

A static IP address can be set to the transceiver. If you set a global IP address to your router, you can use the Terminal mode or Access Point mode without any software applications.



Connection example (Access Point mode)

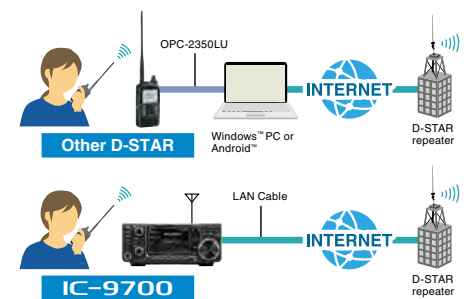

- * These functions can be used only when using through D-STAR G3 repeater.
- * See the instruction manual that comes with the transceiver when operating.

Comprehensive Menus for Satellite Operation

The Normal and Reverse Tracking Functions simultaneously increase or decrease both the downlink and uplink frequencies in the same steps. The AFC Function follows the frequency change caused by the Doppler effect, thus maintaining a stable receive condition. The IC-9700 has 99 satellite memory channels.

Audio Scope Function

Making good use of the Audio Scope function, various audio characteristics, such as microphone compressor level, filter width, notch filter width, and keying waveform in the CW mode can be monitored. Transmit or receive audio can either be displayed on the FFT scope and the oscilloscope.

Other Features

- UDP Hole Punch function
- Photo Sharing function - send, receive and display photos through the radio
- Loud and clear audio
- Compatible with the RS-BA1 Version 2 and CI-V commands
- Built-in server function
- Digital Twin PBT
- CW functions: Full break-in, CW memory keyer, CW reverse, CW auto tuning
- SD card slot
- TX/RX audio recording
- Screen capture ...and more



Controller

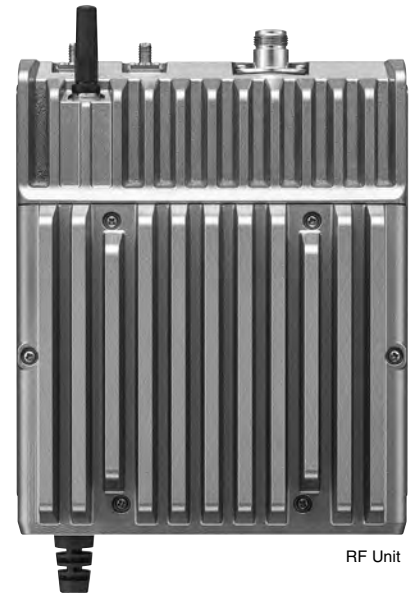

RF Unit

144, 430, 1200, 2400, 5600 MHz +10 GHz ALL MODE TRANSCEIVER IC-905

All Mode with 144, 430, 1200, 2400, 5600 MHz + 10 GHz

Ultimate Frequency Stability with GPS-Controlled Oscillator

Wideband Span Real-time Spectrum Scope

Explore the World of Microwave

The IC-905 is the industry's first microwave rig in the 144, 430, 1200, 2400, 5600 MHz and 10 GHz* bands. Multi-mode operation including SSB, CW, AM, FM, RTTY, D-STAR DV/DD, and FM-TV (Amateur TV). Output power is 10 W on 144, 430, 1200 MHz, 2 W on 2400, 5600 MHz, and 0.5 W on 10 GHz.

* CX-10G is required for 10 GHz operation.

GPS-Controlled Oscillator for Ultimate Frequency Stability

Frequency accuracy and stability are required for SHF band operation. Even with a high-performance OCXO, the frequency gradually changes due to temperature and aging. To solve this problem, the IC-905 uses a high-precision 1 pulse-per-second (1 PPS) clock signal from an internal GPS (GNSS) receiver to enable advanced frequency control.

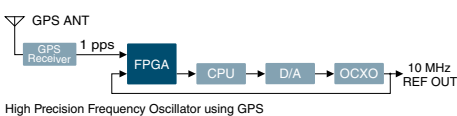

Optional 10 GHz Transverter, CX-10G

The CX-10G transverter provides 10 GHz operation by converting from a 2400



MHz IF signal. 10 GHz operation becomes more approachable and easier to work.

Separate Controller and RF Unit

The IC-905 is the industry's first super efficient microwave base station with the RF unit designed to be at the base of the antenna, rather than in the shack. This design eliminates signal loss due to costly, long coax feed line runs found in legacy SHF designs. Optional 50 m or 20 m controller cable is available with the IC-905.

Less Signal Loss

With the RF unit mounted at the antenna, transmit and receive signals are at their maximum efficiency as the coax feed line is measured in inches rather than feet, keep signal loss to a minimum.

Power Supplied through the Controller Cable

The DC power is supplied from the controller to the RF unit through the controller cable, making it possible to supply power with a low loss. Moreover, optional CX-10G's power is supplied from the IC-905 RF unit.

Wideband 50 MHz Span Real-time Spectrum Scope

A high-performance real-time spectrum scope and waterfall display are built in. The real-time spectrum scope can be adjusted for Center, Fixed, and Scroll mode, and it covers a wide bandwidth of up to 50 MHz span.

Full D-STAR Functions

DV, DD mode, DR function, Terminal mode, and Access Point mode enable easy use of D-STAR. It is also possible to send, receive, and view received pictures with the IC-905.

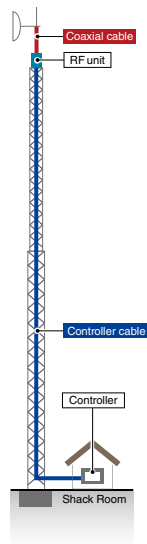

ATV (Amateur TV) Mode

The IC-905 is compatible with the ATV (FM-TV, NTSC, PAL, or SECAM) mode. With an analog camera connected, the IC-905 can transmit video, and receive a real-time video. Furthermore, received videos can be monitored on an external display through the AV-output.



A Variety of Optional Antennas

Optional Collinear antennas for 2400 MHz, 5600 MHz, and 10 GHz are available. Additionally, a high-performance parabolic antenna for 10 GHz is also available.

Collinear antenna
AH-24 for 2400 MHz
AH-56 for 5600 MHz
AH-100 for 10 GHz

Parabolic antenna
AH-109PB for 10 GHz
The CX-10G can be installed in the back of the antenna

Other Features

- SD card slot • USB Type-C™ connection for PC and mobile device • Power Amp thermal protection function • ΔTX, RIT and AFC (Automatic Frequency Control) function
- One-Touch FT8 mode preset • Quick Data mode setting for SSTV, RTTY, PSK31, JT65B and FT8 • AMPS hole pattern and 1/4-20 tripod mount for controller unit • Two call channels for each band (2 × 6 bands)
- 500 memory channels divided into up to 100 groups • 50 scan edges, 2500 repeater memories and 300 GPS memories

Experience
in video



DIGITAL



Bluetooth®



Display example of real-time spectrum scope and waterfall



Touch screen display



Menu screen example

HF/50/144/430 MHz MULTIMODE PORTABLE TRANSCEIVER **IC-705**

“Base Station” Performance
in the Palm of Your Hand

RF Direct Sampling System

Real-Time Spectrum Scope
and Waterfall Display

HF to UHF Multimode

From HF to 50/144/430 MHz, you can enjoy a variety of bands in the D-STAR DV, SSB, CW, RTTY, AM and FM modes. The IC-705 receives continuously from 30 kHz through the 144 MHz band. You can also enjoy FM broadcast and air band reception.

RF Direct Sampling System

The IC-705 employs an RF direct sampling system, where RF signals are directly converted to digital data. Then processed in the FPGA (Field-Programmable Gate Array), making it possible to simplify the circuit construction as well as reducing internal noise that can mask weak signals.

* The down-conversion IF sampling method is used for 25 MHz and above.

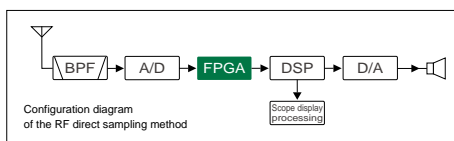

Real-Time Spectrum Scope and Waterfall Display

Performance seen with the IC-7300 and IC-9700 spectrum scope is at the tip of your fingers for field operation. You can quickly see band activity as well as finding an open frequency. The Scroll mode automatically keeps the operating signal within the scope range.

Large Touch Screen Colour Display

The large 4.3" colour TFT touch LCD, same size as the IC-7300 and IC-9700, offers intuitive operation of functions, settings, and various operational visual aids, such as the band scope, waterfall, and audio scope functions.

One-Touch FT8 Mode Preset

Preset memory offers smooth FT8 mode operation. You can start FT8 mode operation only by selecting [FT8] from PRESET menu. Up to five preset memories can be stored.

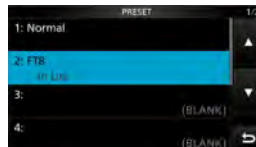

Compact and Lightweight Design

“Base Station” performance in the palm of your hand! You will quickly see how this compact radio is rugged, for outdoor use, in a small, lightweight package, weighing approximately 1.1 kg.



Li-ion Battery Pack or 13.8 V DC External Power Supply

Utilizing the high capacity Li-ion battery from the ID-52E series handheld handheld radios. A 13.8 V DC external power supply can be used for operation and charging of the battery.

Maximum Output Power 5 W (Battery), 10 W (13.8 V DC)

In portable mode, the IC-705 has the maximum output power of 5 W from the BP-272 or BP-307 which can last approximately 3 or 4.7 hours*. This is perfect for true 5 W QRP as well as the 0.5 W QRP operations. Once you setup with a 13.8 V DC power source, you have up to 10 W.

* TX : RX : Standby = 1 : 1 : 8 (The Power Save function ON, in the FM mode)

WLAN/Bluetooth® Technologies

Utilize WLAN/Bluetooth® technologies for linking and remote control, for true wireless operation. The VS-3 headset (optional) enables more comfortable operation via Bluetooth®.

GPS Functions

An internal GPS receiver and antenna enhance your operations by providing location logging*, RX/TX locations via D-PRS, “Near Me” repeater search/scan, QSO recording with metadata*, and internal clock synchronization.

* A microSD memory card is required.

D-STAR Functions

Enjoy the latest DV mode features with the IC-705. Have direct access to the D-STAR network with Terminal/Access point modes. Additionally, the IC-705 has the Photo Sharing feature introduced with the IC-9700. Share photos, without the need of a computer with other users.

Other Features

- microSD card slot
- USB micro-B connector
- Programmable speaker microphone, HM-243
- Optional antenna tuner, AH-705 (See page. 7)
- Optional backpack, LC-192, ideal for field operations



LC-192 Multi-function backpack

For more information about
the Multi-Function
Backpack, LC-192



DIGITAL



DR (D-STAR Repeater) function operation



Near repeater function



SD card slot for saving data

HF/VHF/UHF TRANSCEIVER IC-7100

Intuitive Touch Screen Interface

Controls at Your Fingertips
with an Angled Display

HF, 50/70/144/430 MHz Multi-band

Touch Screen Control with an Angled Display

The radio control head features a large, multi-function, "touch screen" dot-matrix LCD display that is positioned for easy view and operation. The controller is compact in size, making it ideal for limited vehicle or desktop space.

Resistive Touch Screen

The 48.6x75.9 mm; 1.91x2.99 in large resistive touch screen display can be operated while wearing gloves.

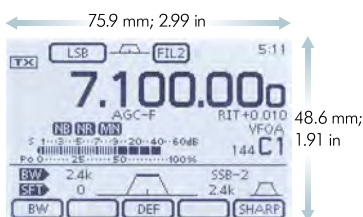

HF, 50/70/144/430 MHz Multi-band

The IC-7100 fully covers the HF, 50, 70, 144, 430 MHz amateur bands in multiple modes, providing 100 W on HF/50 MHz bands, 50 W on 70/144 MHz band and 35 W on 430 MHz band.

Digital Features Controlled by the IF DSP

A high-performance 32-bit floating point IF DSP delivers rich digital signal processing features, including digital IF filter, digital twin PBT, noise reduction, CW auto tune, etc. Those digital features work on all bands from HF to V/UHF bands.

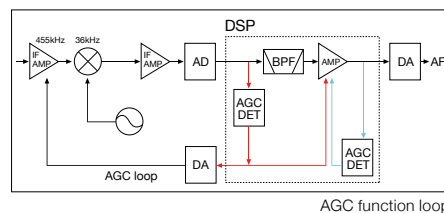

AGC function loop

Built-in RTTY Functions

The built-in RTTY decoder enables you to instantly read an RTTY message on the display. Your RTTY operating log, both TX and RX, can be recorded on an SD card. The eight RTTY memories can memorize and transmit often used RTTY sentences.

D-STAR DV Mode (Digital Voice + Data)

The IC-7100 provides D-STAR (Digital Smart Technologies for Amateur Radio) DV mode digital voice and low-speed data communication.

IDR (D-STAR Repeater) Function Operation

The DR function operation makes the D-STAR operation simple and straightforward, even if you are new to D-STAR.

Repeater Search Function

With an external GPS receiver*, this function searches nearby D-STAR repeaters from the internal database, based on your location.

* External GPS receiver or manual position data input required.

Controller Mounted Speaker and Jacks

The unique remote head design is perfect for providing loud, clear audio as well as jacks for an external speaker/headphones, key and microphone.

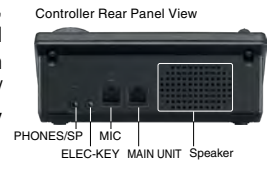

Controller Rear Panel View

SD Card Slot for Saving Data

When used with an SD card, the SD card can store various contents, including voice memory, Memory channels, and D-STAR repeater memories. Other personal settings can be saved to the SD card and loaded into the transceiver.

Other Features

- DSP controlled AGC function loop
- Easy vehicle mounting with the optional MBF-1
- RS-MS1A remote control software for an Android™ devices (Send and receive pictures only)
- Optional RS-BA1 Version 2 IP remote control software
- CW full break-in, CW receive reverse, CW auto tuning
- Optional multi-function microphone, HM-151
- Band scope and SWR graphic display
- RF speech compressor controlled by the DSP
- Voice memory function
- Multi-function meter
- 495 regular, 4 call, 6 scan edge and 900 DR function repeater channels
- 4 TX voice memories
- ±0.5 ppm frequency stability
- Auto reply function*
- Digital callsign squelch (DSQL) and digital code squelch (CSQL)*
- 12.5 kHz IF output for DRM (Digital Radio Mondiale) receive

* D-STAR DV mode only

Linear Amplifier



The wait is almost over.

HF/50 MHz 1 kW LINEAR AMPLIFIER IC-PW2

High Power and Full Duty Cycle Operation

Increased Linearity and Clean Transmission

2 x 6 Automatic Antenna Selector

High Power and Full Duty Cycle

The IC-PW2 uses new 65 V LDMOS power transistor and a high efficiency power supply. A 1 kW output at full duty cycle can be achieved with 200 V AC input*. It can be operated at full power as soon as power is turned ON. (* 180~264 V AC required)

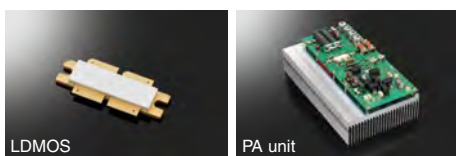

Detachable Controller

A remote control cable enables the amplifier to be mounted away from the radios for a big station installation, in a small shack space. The 4.3 inch colour screen is a touch screen with a graphical user interface. Connected antennas are graphically shown on the display for easy recognition.



Antenna select screen example

Increased Linearity & Clean Transmission

The IC-PW2 has succeeded in realizing the world's first DPD as a linear amplifier for amateur radio in combination with the IC-7610. This technology corrects the signal distortion from the IC-PW2, by applying inverse distortion to the output signal from the IC-7610 exciter in advance*.

* Not applied for non-linear modulation such as FM, FSK and MSK modes.

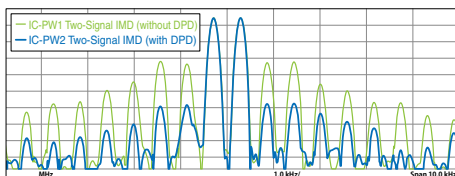

2 x 6 Automatic Antenna Selector

Two radio input connectors and six antenna connectors provide fully automatic antenna switching capabilities. Each antenna can be switched independently in conjunction when changing bands on the radios. Moreover, even when transmitting on one radio, the other radio can receive on a different band with the Transmitter lockout function. As a result, Single Operator Two Radios (SO2R) operation in a contest can be realized with one IC-PW2.



RX In/Out Connectors for Multi-band BPF

User supplied bandpass filters (BPF), preamps and attenuators can be connected to the [Rx In/ Out] connectors. When two radios are used with the IC-PW2, one multi-band BPF can be shared with these radios

by switching the receiving radio. In addition, the band switching of multiband BPF can be controlled from the band data output connector.

One Multi-band BPF Configuration Example (New from IC-PW2)

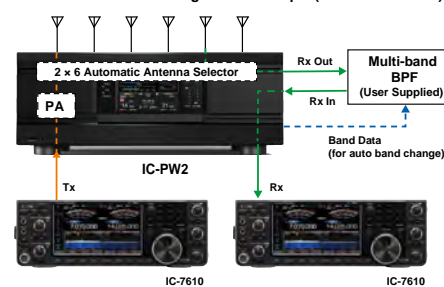

Other Features

- High-efficiency and low noise cooling system
- Various error detection circuits protect internal components
- PC remote control operation*1 through a LAN or Internet
- An SD card slot for saving settings and firmware updates
- Built-in automatic antenna tuner
- Remote AUX jack for controlling an automatic telescopic antenna
- Antenna quick select function temporarily set to the antenna connector such as for a dummy load
- Transmitter Lockout function*2 for the SO2R operation
- With current Icom radios, you can get the full performance of the IC-PW2 with wide compatibility
- Effortless operation, even when connected to non-Icom radios

*1 Software is in planning at this stage.

*2 For IC-7300/IC-7610/IC-7851

REAR PANEL VIEW



This picture shows the panel layout, but cables are not shown.

Remote Control & Antenna Tuners

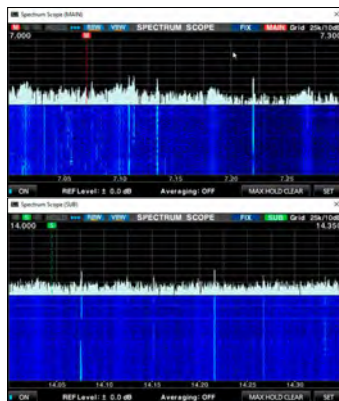

Dual spectrum scope example

Low Latency, High Quality Audio Over an IP Network

The RS-BA1 Version 2 offers real-time operation with low latency, high quality audio. You can use the transceiver installed in another room using your home network, or even from a remote location over the Internet*.

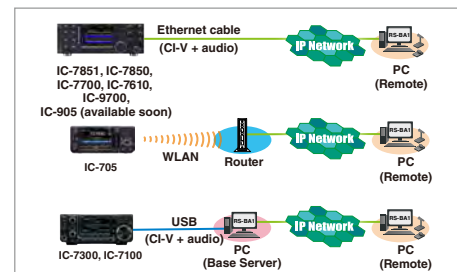

* A static public IP address or Dynamic DNS is required to the base station (Server) PC, when you configure the remote control system through the Internet.

IP REMOTE CONTROL SOFTWARE

RS-BA1 Version 2

Dualwatch Operation with Dual Spectrum Scopes

Covers Most Functions and Modes

Optional USB Remote Encoder RC-28

Dualwatch Remote Control Operation

The RS-BA1 Version 2 provides IP remote control capability. The dualwatch operation and dual spectrum scopes with the waterfall functions* can be used on your remote PC. Single band transceiver can also be used with Version 2.

* Only for the IC-7851, IC-7850 and IC-7610.

Covers Most Functions and Modes

Most functions and modes of your transceiver, including interference rejection functions and IF filter settings, can be controlled using the CI-V commands. The RIT tuning knob and ΔTX functions are added from Version 2.

Optional RC-28 Remote Encoder

The optional RC-28 USB remote encoder brings a hardware dial/transmit function for realistic dial operation.



Note for original version RS-BA1 users: Free upgrade service from RS-BA1 to RS-BA1 Version 2 is not available. To obtain the new features in the RS-BA1 Version 2, the purchase of a new software package is required.



AUTOMATIC ANTENNA TUNER AH-730

1.8 – 50 MHz Frequency Coverage with 7 m or longer wire antenna

2 – 3 Seconds High Speed Tuning

IPX4 Water Resistant

Wide Frequency Coverage

With a 7 m or longer wire element, all band matching is possible from the 1.8 MHz band to the 50 MHz band.

Minimum RF Output for Tuning

The AH-730 emits only 0.3 W of RF output from the antenna during tuning operation.

Tuning Memories

The AH-730 has 45 memories to store the minimum SWR settings. When re-tuning the same frequency, matching can be achieved in about 1 second.

• Compatible with IC-7610, IC-7300 and IC-7100



AUTOMATIC ANTENNA TUNER AH-705

1.8 – 50 MHz Frequency Coverage with 30 m or longer wire *

SO-239 Antenna Connector for 50 Ω Antenna such as Dipole or Yagi

PL-259 Plug or Terminal Connector Supplied for a Long Wire Antenna

* 3.5 – 50 MHz coverage with 7 m or longer antenna

• Alkaline Batteries or External 13.8 V DC*, 2-way Power Sources

* 13.8 V DC should be taken directly from an external power supply, not through the IC-705.

• Latching Relays Used for Saving Power Consumption

• 190 × 105 × 40 mm, 450 g* Compact Design
* Battery cells are not included.

• Compatible with IC-705



Wire antenna installation example



50 Ω antenna example



DIGITAL



2.3 inch Large Colour Display

The ID-52E is equipped with a colour display. The display size is increased to 2.3 inches, 320 x 280 pixels to achieve excellent viewability. The display background colour is selectable from black and white.

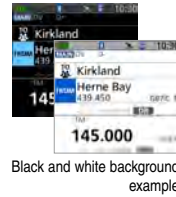

Black and white background example

V/V, U/U, V/U Dualwatch

The Dualwatch function monitors the VHF/VHF, UHF/UHF and VHF/UHF bands simultaneously.* You can also receive two DV signals at the same time.

* AM/AM mode Dualwatch is not possible.

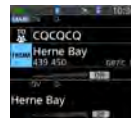

V/U, V/V Dualwatch example

Waterfall Display

You will have an overview of the band conditions at a glance. The waterfall display shows the changes of signal level in chronological order.

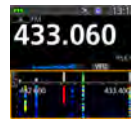

Waterfall display

Picture Sharing Functions

The ID-52E has the popular Picture Sharing functions introduced in the IC-9700 and IC-705. Share pictures with other users and see received pictures on the colour display. Pictures taken on a smart device can be wirelessly transferred to the ID-52E through Bluetooth®.



Picture sharing example

Bluetooth® Connection

You can easily connect to a smart device through Bluetooth®. The RS-MS1A for Android™ or RS-MS11 for iOS™ can wirelessly control the ID-52E.

Terminal/Access Point mode*1 *2

Connect the ID-52E to the Internet through a PC or Android™ device. The Terminal mode and Access Point mode enable you to access the D-STAR network, even from areas where no D-STAR repeater is accessible.

Terminal mode



Access point mode



*1 The RS-MS3W for Windows™ PC or RS-MS3A for Android™ device required. USB data cable is separately required.

*2 Compatible with Icom RS-RP3 gateway software only.

Other Features

- Independent FM broadcast receiver
- DV/FM repeater search function
- DV fast data mode
- Integrated GPS receiver
- microSD card slot
- Micro USB connector
- IPX7 waterproof construction
- 5 W output power and 750 mW loud audio
- Voice recording functions
- CS-52 software can be downloaded from the Icom website

VHF/UHF DIGITAL TRANSCEIVER ID-52E

2.3 inch Large Colour Display

V/V, U/U, V/U Dualwatch Including DV/DV Mode

Picture Sharing Functions & Bluetooth® Connection

DIGITAL



V/V, U/U, V/U Dualwatch

The Dualwatch function monitors the VHF/VHF, UHF/UHF and VHF/UHF bands simultaneously.* You can quickly respond to a call from the Main and Sub bands.

* DV/DV mode cannot be listened at the same time.

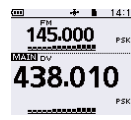

V/U, V/V Dualwatch example

Waterfall Display

You will have an overview of the band conditions at a glance. The waterfall display shows the changes of signal level in chronological order.

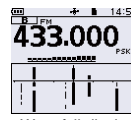

Waterfall display

Picture Sharing Functions

You can share pictures with each other in the DV mode. With a picture utility software, ST-ID50A/W, pictures on your smart device or PC can be used for picture sharing through a USB cable connection. You can enjoy sharing pictures together with voice messages.

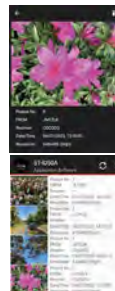

Built-in GPS Receiver

Auto Position Reply function, GPS Logger function, Near Repeater function and Grid Locator are available.

Build Your Own Internet Gateway

If there are no D-STAR repeaters in your area, connecting the ID-50E to a Windows™ PC or an Android™ device, to an the Internet gateway (using Terminal mode and Access Point mode) enables you to access the D-STAR network. Connect the ID-50E to the Internet through a Windows™ PC or an Android™ device.

USB Type-C™ Connector

The ID-50E has a USB Type-C™ connector which is widely used in the industry. The Multi-function USB port can charge the battery pack*, and has a data host function for connecting with various device.

* USB PD is not supported.

Other Features

- VHF airband and FM broadcast receiver
- DV/FM repeater search function
- DV fast data mode
- microSD card slot
- IPX7 waterproof construction
- 5 W output power and 750 mW loud audio
- Voice recording functions
- CS-50 software can be downloaded from the Icom website
- External DC power jack
- Battery packs can be shared with the IC-705, ID-51, ID-52 series

VHF/UHF DIGITAL TRANSCEIVER ID-50E

V/V, U/U, V/U Dualwatch

Picture Sharing Functions with ST-ID50A/W

Built-in GPS Receiver



1500 mW Powerful Audio

In combination with a BTL amplifier and Icom's custom speaker, the IC-T10 delivers 1500 mW (typ.) powerful audio even in noisy environments. In addition, the optional HM-222HLWP also provides 1500 mW (typ.) loud audio from the attached speaker-microphone.



1500 mW powerful audio



Optional HM-222HLWP

FM Broadcast Receiver

The IC-T10 covers 136–174, 400–479 MHz and 76–108 MHz*. You can listen to a FM broadcast station.

* EUR version. Receiver working range.

The Home Button on the Top Panel

The IC-T10 has the home button on the top of the panel. When pushing the home button, you can quickly access the often used channel.

Download Free Programming Software

The CS-T10 programming software for Windows™ PC can be downloaded from the Icom Website. Editing memory channels and other settings can easily be made from your PC.

Other Features

- User programmable side buttons for quick access for user-selected functions
- Optional AD-149H power supply adapter allows to use the radio by external DC power
- BC-213, rapid charger and AC adapter are supplied
- CTCSS/DTCS code for repeater, tone squelch and pocket beep operation
- 16 DTMF autodial memories
- FM narrow mode
- Priority, Program, Memory, Skip, Tone and other useful scan capabilities
- VOX capability for hands-free operation
- Direct-conversion system eliminates IF stages
- 200 memory channels, 2 Call channel and 6 scan edges

VHF/UHF DUAL BAND FM TRANSCEIVER

IC-T10

5 W of Output Power
on Both VHF and UHF Bands

1500 mW Powerful Audio

IP67 Waterproof and MIL-STD 810G

IP67 Waterproof and Dust-Tight

The IC-T10 can withstand submersion in 1 m depth of water for 30 minutes. This rugged construction provides dust-tight protection, making it suitable for outdoor operation.



11/10 Hours of Long Battery Life*

With supplied 2400 mAh (typ.) large capacity BP-280 battery pack, the IC-T10 can use the radio for up to 11/10 hours*

* VHF/UHF with external speaker-mic rated audio.
TX:RX:Standby = 1:1:8 (60: 60: 480 seconds)

DIGITAL



DV/DV Dualwatch

The ID-5100E can receive both FM/FM and FM/DV mode signals simultaneously. Two DV mode signals can be monitored for receive on either channel. You can check other repeaters or other channel activities while waiting for the main repeater.

MAIN		DV	19:40	+	DV	SUB
DUP-	CQCCQC	DUP-	CQCCQC			
TO	Herne Bay	TO	Herne Bay			
FROM	145.66200 0B71C C	FROM	439.450 0B71C B			
H		H				
D-1	RX>CS	CD	CS	SCAN	MONI	

DV/DV Dualwatch (DR function) example

* Main band audio has priority if two DV signals are received at the same time.

DV/FM Repeater Search Function

The DV/FM repeater search function assists you in accessing nearby repeaters, even in areas you are visiting for the first time. The function searches for a nearby repeater using the repeater memories with the GPS location information.

* To use the repeater search function, the position data of the repeater is required.

Other Features

- SD card slot
- VS-3 Bluetooth® headset
- RS-MS1A Android™ application
- DV fast data mode
- 50 W output power
- Repeater memory channels increased to 1500
- CTCSS and DTCS with Split tone function
- Sub band mute auto
- D-PRS functions
- Convenient memory contents management using CSV format
- Speech function announces the operating frequency, mode and received call sign (DV mode)
- Independent main, volume and SQL knobs for A/B bands
- AM airband Dualwatch
- Download-free programming software, CS-5100
- 1750 Hz tone burst

VHF/UHF DIGITAL TRANSCEIVER ID-5100E

Intuitive Touch Screen Operation

DV/DV Dualwatch

Integrated GPS Receiver

Intuitive Touch Screen Operation

The intuitive touch screen interface provides quick and smooth operation. The large 5.5 inch display (320 × 128 pixels) responds naturally to the touch – allowing you to change settings, enter frequencies and edit Memory channels with ease.



Vehicle installation example (Using optional MBF-1 mount base and MBA-2 controller bracket)

Integrated GPS Receiver

The integrated GPS receiver shows your own location, course, speed and altitude on the display. The GPS location information can be used for exchanging location reports, tracking the GPS log, and more.

Optional VS-3 Bluetooth® Headset

The optional VS-3 Bluetooth® headset can wirelessly control the IC-2730E with three programmable keys and a PTT button. It also provides VOX operation for hands-free communication.

* Optional UT-133A Bluetooth® unit must be installed in the IC-2730E.

Easy Controller Mounting with the Optional MBF-1

The combination of the optional MBF-1 suction cup mounting base and MBA-5 controller bracket provides easy tilt and swivel adjustments. The large suction cup can be mounted on flat surfaces, and can be easily removed.

Other Features

- Controller attachment to the main unit with optional MBA-4
- 50 W of output on VHF/UHF
- Built-in CTCSS and DTCS tones with split tone functions
- Wide band receiver (118–174 and 375–550 MHz)*
- HM-207 remote control microphone
- CS-2730 Free download PC programming software
- Versatile scanning capability
- Squelch delay and squelch attenuator
- Sub band auto mute function
- Sub band busy beep function
- Auto power off
- 16 DTMF auto dial memories
- CI-V remote control capability (through the OPC-478UC)

* Receiver range differs, depending on the version.



VHF/UHF DUAL BAND TRANSCEIVER IC-2730E

50 Watts of Output Power on Both VHF and UHF Bands

VHF/VHF, UHF/UHF Simultaneous Receive

Optional Wireless Remote Control Bluetooth® Headset VS-3

VHF/VHF, UHF/UHF Simultaneous Receive

The IC-2730E provides VHF/VHF, UHF/UHF simultaneous receive capability, as well as VHF/UHF receive. A simple one-touch of a button enables you to change between the main (transmit) band and sub band.

Independent Controls for Each Band

Operating two bands simultaneously is very simple with the symmetric layout with a wide LCD display showing both band settings in an easy to read, side by side format. Various operations, including frequency tuning, is straight forward and smooth.

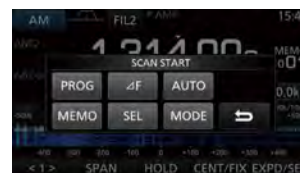

Scan setting screen



Function menu for touch screen



Pop up menu appears by pushing DIAL B

COMMUNICATIONS RECEIVER **IC-R8600**

0.01–3000 MHz Super Wideband

**Decode Digital Protocols
(P25, NXDN™, dPMR™, D-STAR, DCR)**

**Real-Time Spectrum Scope
with Waterfall**

0.01–3000 MHz Super Wideband Coverage

The IC-R8600 decodes various digital protocol signals including P25 (Phase 1), NXDN™, dPMR™, D-STAR, Japanese DCR (Digital Convenience Radio). It also receives conventional analogue signals such as USB, LSB, FSK, CW, AM, S-AM (Synchronous-AM), FM and WFM modes, covering 10 kHz to 3 GHz wideband in 1 Hz steps.

Software Demodulation in FPGA Processing

The IC-R8600 utilizes FPGA (Field Programmable Gate Array) and DSP units for demodulation, decoding and most of signal processing. Direct HF signals and intermediate frequency signals, which are converted from VHF/UHF signals, are digitized in a 14-bit A/D converter and transferred to the FPGA and DSP for optimal processing. The high-rate 122.88 MHz sampling frequency used for the A/D converter results in superior aliasing and image reception reduction.



FPGA

Superb Receiver Performance

The IC-R8600 has 11 discrete RF bandpass filters in the HF bands and 13 bandpass filters in the VHF/UHF bands. To prevent overflow, only the intended signal is passed, while any out of range strong interference signals are rejected. The IC-R8600 provides +30 dBm IP3 and 105 dB dynamic range at 14.1 MHz. IP3 performance is +10 dBm at 144 MHz and 0 dBm at 430 MHz.

Variety of Scan Functions

A variety of scan functions effectively and thoroughly search for desired stations. The IC-R8600 scans up to 100 channels per second in the memory scan mode.

- Program scan/Fine program scan • Δ f scan/ Δ f fine scan
- Priority scan • Memory scan
- Selected memory scan • Selected mode memory scan
- Auto memory write scan

Real-time Spectrum Scope with Waterfall Function

The high-resolution real-time spectrum scope provides class-leading performance in resolution, maximum 30 frames per second* fast sweep speed, ± 2.5 MHz wide scope span (display range) and 110 dB of dynamic range (at ± 2.5 kHz span). The waterfall screen enables you to find weak signals by showing the spectrum change over time.

(* Approximate)

Quick, Smooth and Intuitive Operation

To efficiently acquire intended signals, the IC-R8600 user interface provides quick and accurate operation. The large 4.3-inch colour display, with touch screen function, is configured to collect operating information. By tapping indications and icons on the screen, the setting menu will pop up and parameters can easily be adjusted.

SD Card Slot for Receiver Recorder

The recorder function can record received audio onto an SD card in WAVE format. The recorded voice audio can be played back on the receiver or a PC. When a 32 GB SD card is used, up to 270 hours of recording is possible. In addition, the screen capture function saves a snap shot of the screen in PNG or BMP format on the SD card.

* An SD card is required.

I/Q Signal Output

The I/Q signal output function* enables you to derive digital IF signals from the I/Q output port to a PC through a USB cable. It can be used for analysing spectrum or decoding signals. The IC-R8600 outputs I/Q data to the third-party software HSDR, and the IC-R8600 can be controlled by the HSDR.

* This function requires firmware version 1.3 or later. Download the IC-R8600 USB I/Q package for HSDR.

Other Features

- Absolute Value of RSSI (Received Signal Strength Indicator)
- 2000 regular Memory channels
- Remote control function through IP network or USB cable
- 3 antenna connectors: an SO-239 type and a phono (RCA) connector for HF and a type-N connector
- Clock and NTP function
- Center tuning meter and digital auto frequency control (AFC) for FM, WFM and digital modes
- Built-in Voice synthesizer
- Audio tone functions: HPF/LPF, bass, treble and de-emphasis
- Decode multiple digital code used in digital mode
- IP+ function improves 3rd order intercept point performance
- Main dial friction adjustment
- Dial lock and panel lock
- CI-V remote control command
- RX history log for digital modes



COMMUNICATIONS RECEIVER

IC-R6

**0.1–1309.995 MHz*
Wideband Coverage**

**100 Channels Per Second
High Speed Scan**

**15 Hours of Continuous
Receive Capability**

0.1–1309.995 MHz* Coverage

Amateur stations, AM, FM, short wave broadcasts, air band, marine VHF, PMR446 and a variety of utility communications can be found and listened to.

* Frequency range depending on version.

100 Channels per Second High Speed Scan

The IC-R6 has 100 channels per second high speed scan capability* and variety of scan functions; Auto memory scan, Tone scan, Programmed scan, Memory scan, priority scan, auto memory write scan and more.

* VFO mode scanning.

15 Hours of Continuous Receive Capability*

The IC-R6 is energy-efficient, designed to provide many hours of listening enjoyment on a single charge. With the supplied rechargeable Ni-MH cells (1400 mAh x2), the IC-R6 provides up to 15 hours of continuous receive capability*.

* At 50 mW output using external speaker.









Other Features







- 1300 Memory Channels with 22 Memory Banks
- Voice Squelch Control
- Built-in audio low pass filter
- ± 1.0 ppm high frequency stability (at 25°C)
- Earphone cord antenna for AM aviation as well as FM broadcast
- Ferrite bar antenna for AM broadcast
- DTCS and CTCSS tone squelch and reverse tone squelch
- Optional CS-R6 programming software
- Receiver-to-receiver cloning (optional OPC-474 required)
- Auto power OFF
- Compact, drip-resistant construction
- Duplex operation monitoring
- Automatic LCD backlight
- Dial speed acceleration
- Built-in RF attenuator
- Reversible up/down buttons and dial knob for volume, frequency, memory channel, scan direction and set mode settings
- Optional tube earphone, SP-27

* Frequency range depending on version.

OPTIONAL ACCESSORIES FOR BASE STATIONS, MULTI-BAND & RECEIVERS

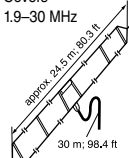
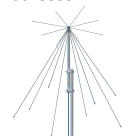





MODEL NAME	HAND MICROPHONES				SPEAKER-MICROPHONE	DESKTOP MICROPHONES		Bluetooth® HEADSET	LINEAR AMPLIFIER
	HM-219	HM-103	HM-151	HM-198	HM-243	SM-50	SM-30	VS-3	IC-PW2
									
IC-7610	✓					✓	✓		✓
IC-7300	✓					✓	✓		(Use with OPC-599)
IC-9700	✓					✓	✓		
IC-905					✓				
IC-705					✓			✓	
IC-7100	(Use with OPC-589)	✓	✓	✓		(Use with OPC-589)	(Use with OPC-589)		(Use with OPC-599)
IC-R8600									







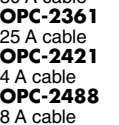
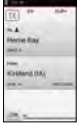

MODEL NAME	EXTERNAL SPEAKERS					AC ADAPTER	ANTENNA TUNERS		AUTO TUNING ANTENNA
	SP-33 Wooden box speaker	SP-35 2.0 m cable SP-35L 6.0 m cable	SP-38 Best design matched for the IC-7300/IC-9700	SP-39AD With DC power supply	SP-41 With two input lines	AD-55NS Input: 100-240 V/1.0 A, Output: 15 V/2.0 A	AH-730 Covers 1.8-54 MHz	AH-705 Covers 1.8-54 MHz	AH-740 Covers 2.5-30 MHz. (Amateur band) OPC-2321 is required.
									
IC-7610	✓				✓		✓		(Use with OPC-2321)
IC-7300	✓	✓	✓		✓		✓		(Use with OPC-2321)
IC-9700	✓	(Use SP-35)	✓		✓				
IC-905									
IC-705								✓	
IC-7100		(Use SP-35)					✓		(Use with OPC-2321)
IC-R8600				✓	✓	✓			

MODEL NAME	CONTROL CABLES		COAXIAL CABLE	FOLDED DIPOLE ANTENNA	OMNIDIRECTIONAL ANTENNA	CARRYING HANDLES	MOBILE MOUNTING BRACKETS	
	OPC-2321 (6.0 m) For use with AH-740 OPC-1465 (10 m) For use with AH-730	OPC-2474 (5.0 m) For use with AH-705	OPC-2475 (5.0 m) For use with AH-705	AH-710 Covers 1.9-30 MHz approx. 24.5 m, 80.5 ft 30 m, 98.4 ft	AH-8000 Covers 100-3335 MHz	MB-121 MB-123	MB-62	MB-118
								
IC-7610	✓			✓		(Use MB-121)		
IC-7300	✓			✓		(Use MB-123)		✓
IC-9700						(Use MB-123)		✓
IC-905								
IC-705		(Use with AH-705)	(Use with AH-705)					
IC-7100	✓						✓	
IC-R8600				✓	✓	(Use MB-123)		

: Applicable
 : Not applicable

OPTIONAL ACCESSORIES FOR BASE STATIONS, MULTI-BAND & RECEIVERS

MODEL NAME	DESKTOP STAND	MOUNTING BASE	CONTROLLER BRACKET	SEPARATION CABLES	MIC ADAPTER CABLE	ADAPTER CABLE	DC POWER CABLES	PROGRAMMING SOFTWARE	REMOTE CONTROL SOFTWARE
	MBF-705 	MBF-1 	MBA-1 	OPC-2253 3.5 m OPC-2254 5.0 m 	OPC-589 8-pin connector microphone to 8-pin modular 	OPC-599 13-pin ACC socket to 7-, 8-pin ACC sockets 	OPC-1457R 30 A cable OPC-1457-1 30 A cable OPC-2095 30 A cable OPC-2361 25 A cable OPC-2421 4 A cable OPC-2488 8 A cable 	CS-9700 ^{*1} CS-905 ^{*1} CS-705 ^{*1} CS-7100 CS-R8600 A USB cable is required for programming.	RS-MS1A ^{*2} For Android™ device 
IC-7610							✓ (Use OPC-1457-1)		
IC-7300						✓	✓ (Use OPC-1457R)		
IC-9700							✓ (Use OPC-2361)	✓ (Use CS-9700)	✓ (Use with OPC-2350LU)
IC-905	✓						✓ (Use OPC-2488)	✓ (Use CS-905)	
IC-705	✓						✓ (Use OPC-2421)	✓ (Use CS-705)	✓ ^{*4}
IC-7100		✓ (Use with MBA-1)	✓	✓	✓	✓	✓ (Use OPC-2095)	✓ (Use CS-7100)	✓ (Use with OPC-2350LU)
IC-R8600							✓ (Use CS-R8600)		

MODEL NAME	REMOTE CONTROL SOFTWARE					USB REMOTE ENCODER	PICTURE UTILITY SOFTWARE	GPS SOFTWARE	TIME ADJUSTMENT SOFTWARE
	RS-MS1I ^{*3} For iOS™ device 	RS-MS3A ^{*2} For Android™ device 	RS-MS3W ^{*1} For Windows™ PC 	RS-R8600 	RS-BA1 (Version 2) 	RC-28 	ST-4001A ^{*2} ST-4001I ^{*3} ST-4001W ^{*1} 	ST-4002A ^{*2} 	ST-4003A ^{*2} ST-4003W ^{*1} 
IC-7610					✓	✓			✓
IC-7300					✓	✓ (Use with RS-BA1)			✓
IC-9700		✓ (Use with OPC-2350LU)	✓ (Use with OPC-2350LU)		✓	✓ (Use with RS-BA1)	✓	✓ (Use with OPC-2350LU)	✓
IC-905		✓ ^{*9}	✓ ^{*9}		✓ (Available later)	✓ (Use with RS-BA1)	✓		✓
IC-705	✓ ^{*5}	✓ ^{*6}	✓ ^{*7}		✓	✓ (Use with RS-BA1)	✓		✓
IC-7100					✓	✓ (Use with RS-BA1)		✓ (Use with OPC-2350LU)	✓
IC-R8600				✓		✓ (Use with RS-BA1)			

MODEL NAME	DATA CABLES	BATTERY PACKS		DESKTOP CHARGER	AC ADAPTER	BACKPACK	
	OPC-1529R RS-232 cable for an external GPS or a PC 	OPC-2350LU 2.5 mm jack to USB Type-A or micro-B OPC-2417 USB micro-B to micro-B OPC-2418 USB Type-C™ to micro-B	BP-272 (Li-ion) 7.4 V/ 1880 mAh (min.), 2000 mAh (typ.) 	BP-307 (Li-ion) 7.2 V/ 3050 mAh (min.), 3150 mAh (typ.) 	BC-202IP2 Rapid charger 	BC-1235 ^{*9} 12 V/1.0 A for BC-202IP2 	LC-192 Multi-function backpack 
IC-7610							
IC-7300							
IC-9700	✓	✓ (Use OPC-2350LU)					
IC-905							
IC-705		✓ (Use OPC-2417 or OPC-2418)	✓	✓	✓	✓	
IC-7100	✓	✓ (Use OPC-2350LU)					
IC-R8600							

: Applicable : Not applicable

^{*1} Free download software for Windows™ PC. Download from the Icom website: www.icomjapan.com/support/firmware_driver/

^{*2} Free download Android™ app. Download on Google Play™. ^{*3} Free download iOS™ app. Download on the App Store.

^{*4} Use with OPC-2417, OPC-2418 or Bluetooth® connection for Android™ device. ^{*5} Use Bluetooth® connection for iOS™ device.







^{*6} Use with OPC-2417 or OPC-2418. ^{*7} Use a USB cable. USB cable Type-A: User supplied. Type-C: OPC-2418.

^{*8} USB Type-C™ cable is required. ^{*9} AC adapter may be supplied with the BC-202IP2, depending on versions.

Note for the Terminal mode and Access point mode









- Before operating in the Terminal mode or the Access Point mode, BE SURE to check your local regulations or laws.
- You need an Internet connection with an IPv4 Global IP address. If you use a cellular system, you need an IPv4 Global IP address assigned to your Windows™ or Android™ device.
- When operating in the Access Point mode, you need two call signs. One for the Access Point transceiver and one for the Remote D-STAR transceiver.
- For the Access point or Terminal mode operation, please register your MY and Access point call signs with a Gateway repeater/server that has the RS-RP3C installed.









OPTIONAL ACCESSORIES FOR BASE STATIONS, MULTI-BAND & RECEIVERS

MODEL NAME	CONTROL CABLES		ANTENNAS				TRANSVERTER
	OPC-2509 50 m	OPC-2513 20 m	AH-24 2400 MHz BAND COLLINEAR	AH-56 5600 MHz BAND COLLINEAR	AH-100 10 GHz BAND COLLINEAR	AH-109PB 10 GHz BAND PARABOLIC	CX-10G 10 GHz TRANSVERTER
IC-7610							
IC-7300							
IC-9700							
IC-905	✓	✓	✓	✓	(Use with CX-10G)	(Use with CX-10G)	✓
IC-705							
IC-7100							
IC-R8600							









: Applicable
 : Not applicable









OPTIONAL ACCESSORIES FOR HANDHELD RADIOS & RECEIVERS

	BATTERY CASE	BATTERY PACKS				DESKTOP CHARGERS			MULTI CHARGER	AC ADAPTERS
MODEL NAME	BP-273 LR6 (AA)× 3 cells 	BP-272 (Li-ion) 7.4 V/ 1880 mAh (min.), 2000 mAh (typ.) 	BP-307 (Li-ion) 7.2 V/ 3050 mAh (min.), 3150 mAh (typ.) 	BP-280 (Li-ion) 7.2 V/ 2280 mAh (min.), 2400 mAh (typ.) 	BC-202IP2 Rapid charger 	BC-213 Rapid charger 	BC-194 Charger stand 	BC-214N For BP-280/ BP-298/BP-299 	BC-167SD 12 V/500 mA 	
ID-52E	✓	✓	✓		✓*1				✓	
ID-50E	✓	✓	✓		✓*1				✓	
IC-T10				✓		✓*1		✓*1 (Use #41-#43)		
IC-R6							✓ (Use with BC-196SD)			

	AC ADAPTERS					CIGARETTE LIGHTER CABLES	DC POWER CABLE	
MODEL NAME	BC-123SE 12 V/1.0 A 	BC-242 12 V/1.0 A 	BC-157S 12 V/7.5 A 	BC-196SD 4.5 V/0.3 A 	BC-258E 5 V/2 A 	CP-12L with noise filter 	CP-23L 	OPC-254L 
ID-52E	✓ (Use with BC-202IP2)					✓	✓ (Use with BC-202IP2)	✓
ID-50E	✓ (Use with BC-202IP2)				✓ (USB cable required)	✓	✓ (Use with BC-202IP2)	✓
IC-T10	✓ (Use with BC-213)	✓ (Use with BC-213)	✓*1 (Use with BC-214N)			✓ (Use with AD-149H)	✓ (Use with BC-213)	✓ (Use with AD-149H)
IC-R6				✓				









*1 AC adapter may be supplied depending on versions.







	POWER SUPPLY ADAPTER	SPEAKER-MICROPHONES						
MODEL NAME	AD-149H 	HM-243LS Remote control 	HM-183LS Waterproof 	HM-186LS 	HM-222HLWP Waterproof 	HM-158LA 	HM-159LA 	HM-168LWP Waterproof 
ID-52E		✓	✓	✓				
ID-50E		✓	✓	✓				
IC-T10	✓ (Use with CP-12L or OPC-254L)				✓	✓	✓	✓
IC-R6								



	EARPHONE-MICROPHONES				HEADSETS				
MODEL NAME	HM-153LS 	HM-166LS 	HM-153LA 	HM-166LA 	HS-94LWP Earhook type with waterproof connector 	HS-95LWP Neck arm type with waterproof connector 	HS-94 Earhook type with boom microphone 	HS-95 Neck-arm type 	HS-97 Throat microphone type 
ID-52E	✓	✓					✓ (Use with OPC-2006LS)	✓ (Use with OPC-2006LS)	✓ (Use with OPC-2006LS)
ID-50E	✓	✓					✓ (Use with OPC-2006LS)	✓ (Use with OPC-2006LS)	✓ (Use with OPC-2006LS)
IC-T10			✓	✓	✓	✓			
IC-R6									

: Applicable : Not applicable

OPTIONAL ACCESSORIES FOR HANDHELD RADIOS & RECEIVERS

MODEL NAME	EARPHONES		PLUG ADAPTER CABLES		Bluetooth® HEADSET	CARRYING CASES		CHARGER BRACKET
	SP-40	SP-27	OPC-2006LS For VOX operation	OPC-2144 For straight plug microphones	VS-3	LC-193	LC-202	MB-130
								
ID-52E	✓ (Use with OPC-2144)		✓	✓	✓	✓		
ID-50E	✓ (Use with OPC-2144)		✓	✓			✓	
IC-T10								✓ (Use with BC-213)
IC-R6	✓	✓						

MODEL NAME	USB CABLES		PROGRAMMING CABLES		BELT CLIPS	ANTENNA	ANTENNA ADAPTER	PROGRAMMING SOFTWARE
	OPC-2417 USB micro-B to micro-B	OPC-2418 USB Type-C to micro-B	OPC-474 Handheld to handheld	OPC-478UC/-1 Handheld to PC USB cable	MB-127 MB-133	FA-5270C	AD-925MA BNC type antenna connector	CS-52*2 CS-50*2 CS-T10*2 CS-R6
								
ID-52E	✓	✓			(Use MB-127)	✓	✓	(Use CS-52)
ID-50E					(Use MB-127)	✓	✓	(Use CS-50)
IC-T10				✓	(Use MB-133)	✓		(Use CS-T10)
IC-R6			✓	✓		✓	✓	(Use CS-R6)

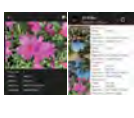
MODEL NAME	REMOTE CONTROL SOFTWARE		PICTURE UTILITY SOFTWARE	
	RS-MS1A*3 For Android™ device RS-MS11*4 For iOS™ device	RS-MS3A*3 For Android™ device RS-MS3W*2 For Windows™ PC	ST-4001A*3 ST-4001I*4 ST-4001W*2	ST-ID50A*3 ST-ID50W*2
				
ID-52E	✓*5	✓*6	✓	
ID-50E	✓*7 (Use RS-MS1A)	✓*7		✓*7
IC-T10				
IC-R6				

: Applicable
 : Not applicable

*2 Free download software for Windows™ PC. Download from the Icom website: www.icomjapan.com/support/firmware_driver/

*3 Free download Android™ app. Download on Google Play™. *4 Free download iOS™ app. Download on the App Store.

*5 Use with OPC-2417, OPC-2418 or Bluetooth® connection for Android™ device. Use Bluetooth® connection for iOS™ device.

*6 USB cable required. Type-A: User supplied. Type-C: OPC-2418. micro-B: OPC-2417. *7 User supplied USB Type-C™ cable required.

RS-MS1A/RS-MS11 Remote Control App

(Free Download Android™/iOS™ Application on Google Play™/App Store)

The RS-MS1A and RS-MS11 allow you to connect the Digital transceiver with an Android™/iOS™ device and remotely control various functions and settings from the Android™/iOS™ device. You can take pictures with your Android™ or iOS™ device, or use stored pictures, and share them over the DV mode.

* An optional Bluetooth® unit (UT-133A) or a data cable (OPC-2350LU) may be required, depending on the transceiver.

Not all functions are usable with the IC-7100.

* Some functions may not work properly, depending on Android™/iOS™ devices used.

* Photo shows RS-MS1A.

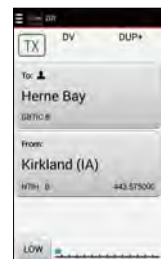



DR function setting example







Repeater map example © Google

OPTIONAL ACCESSORIES FOR MOBILE RADIOS

	HAND MICROPHONES				HANDS-FREE MICROPHONE	Bluetooth® HEADSET	MOUNTING BASE	MOUNTING BRACKET	CONTROLLER BRACKETS
MODEL NAME	HM-198	HM-207	HM-154	HM-232	HM-249	VS-3	MBF-1	MBF-4	MBA-2
									
ID-5100E	✓	✓	✓	✓	✓	(Use with UT-133A)	(Use with MBA-2)	✓	✓
IC-2730E	✓	✓	✓	✓	✓	(Use with UT-133A)	(Use with MBA-5)	✓	

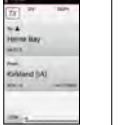
	CONTROLLER BRACKETS	COMBINATION BRACKET	EXTERNAL SPEAKERS		MICROPHONE CABLES	MIC ADAPTER CABLE	CONTROLLER CABLE	DATA CABLES	
MODEL NAME	MBA-5	MBA-4	SP-35 2.0 m cable SP-35L 6.0 m cable	SP-30 4 inch (102.5 mm) diameter speaker	OPC-440 5.0 m OPC-647 2.5 m	OPC-589 8-pin connector microphone to 8-pin modular	OPC-1156 3.5 m	OPC-1529R RS-232 cable	OPC-2350LU USB cable for an Android™ or a PC
									
ID-5100E			✓	✓	✓	✓	✓	✓	✓
IC-2730E	✓	✓	✓	✓	✓	✓	✓		

	PROGRAMMING CABLE	CLONING CABLE	Bluetooth® UNIT	PROGRAMMING SOFTWARE	REMOTE CONTROL SOFTWARE	GPS SOFTWARE
MODEL NAME	OPC-478UC/-1 Transceiver to PC USB cable	OPC-474 Between transceivers	UT-133A	CS-5100*1 CS-2730*1	RS-MS1A*2 For Android™ device	ST-4002A*2
						
ID-5100E	✓		✓	(Use CS-5100)	(Use with UT-133A)	(Use with OPC-2350LU)
IC-2730E	✓	✓	✓	(Use CS-2730)		

: Applicable
 : Not applicable

*1 CS-5100 and CS-2730 are available for free download from Icom website: www.icomjapan.com/support/firmware_driver

*2 Free download Android™ app. Download on Google Play™.

HANDS-FREE MICROPHONE HM-249

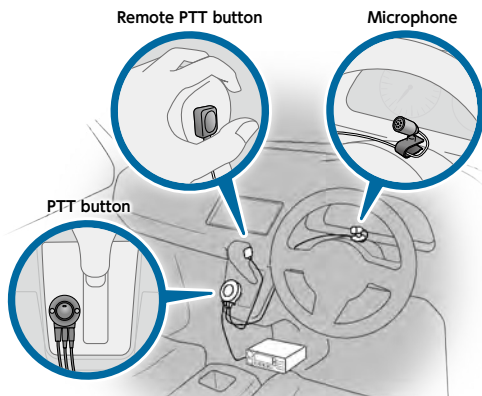

Driver can keep talking, while driving in safety

- Push-ON and push-OFF toggle operation for main PTT button
- Momentary operation for remote PTT button
- LED in Main PTT button lights up when transmitting

Please put these parts in the position where does not influence to your driving operation.

SPECIFICATIONS FOR BASE STATIONS & MULTI-BAND

		IC-7610	IC-7300	IC-9700
General	Frequency coverage <small>(Differs according to version)</small>	Tx: 135 kHz, 1.8, 3.5, 7, 10, 14, 18, 21, 24, 28, 50 MHz bands Rx: 30 kHz–60 MHz* ²	Tx: 1.8, 3.5, 7, 10, 14, 18, 21, 24, 28, 50, 70* ¹ MHz bands Rx: 30 kHz–74.8 MHz* ²	144, 430 MHz, 1.2 GHz (23 cm)* ¹
	Modes	USB, LSB, CW, RTTY, PSK31/63, AM, FM	USB, LSB, CW, RTTY, AM, FM	USB, LSB, CW, RTTY, AM, FM, DV, DD* (* 1200 MHz only)
	Frequency stability	Less than ±0.5 ppm (0°C to +50°C)	Less than ±0.5 ppm (–10°C to +60°C)	Less than ±0.5 ppm (–10°C to +60°C)
	Maximum current drain	23 A at 13.8 V DC	21 A at 13.8 V DC	18 A at 13.8 V DC
	Antenna connector	SO-239 × 2, BNC	SO-239	SO-239 (144 MHz), Type-N (430, 1200 MHz)
	Dimensions (W × H × D; Projections are not included)	340 × 118 × 277 mm	240 × 94 × 238 mm	240 × 94 × 238 mm
	Weight (approx.)	8.5 kg	4.2 kg	4.7 kg
Transmitter	Output power	SSB, CW, RTTY, PSK, FM: 1–100 W AM: 1–25 W Transverter connector (CW): –20 dBm	SSB, CW, FM, RTTY: HF/50 MHz 2–100 W 70 MHz 2–50 W AM: HF/50 MHz 1–25 W 70 MHz 1–12.5 W	SSB, CW, RTTY, FM, DV, DD: 144 MHz 0.5–100 W 430 MHz 0.5–75 W 1200 MHz 0.1–10 W AM: 144 MHz 0.125–25 W 430 MHz 0.125–18.75 W 1200 MHz 0.025–2.5 W
	Sensitivity (typical) <small>Preamp ON SSB, CW, RTTY, AM: at 10 dB S/N FM, WFM: at 12 dB SINAD</small>	SSB, CW (2.4 kHz): 1.8–29.999 MHz 0.16 µV 50 MHz band 0.13 µV AM (6 kHz): 0.5–1.799 MHz 6.3 µV 1.8–29.999 MHz 2.0 µV 50 MHz band 1.0 µV FM (15 kHz): 28–29.7 MHz 0.5 µV 50 MHz band 0.32 µV	SSB, CW (2.4 kHz): 1.8–29.999 MHz 0.16 µV 50–54 MHz 0.13 µV 70–70.5 MHz 0.16 µV AM (6 kHz): 0.5–1.8 MHz 12.6 µV 1.8–29.999 MHz 2.0 µV 50–54 MHz 1.0 µV 70–70.5 MHz 1.0 µV FM (15 kHz): 28–29.7 MHz 0.5 µV 50–54 MHz 0.25 µV 70–70.5 MHz 0.25 µV	SSB/CW: (Filter: SOFT) Less than 0.11 µV AM: Less than 1.0 µV FM: Less than 0.18 µV DV: Less than 0.35 µV DD (1200 MHz only): Less than 1.59 µV (Preamp ON for 144 MHz, 430 MHz and 1200 MHz)
Receiver	Selectivity	SSB: 2.4 kHz/–6 dB (2.4 kHz) 3.6 kHz/–60 dB CW: 500 Hz/–6 dB (500 Hz) 700 Hz/–60 dB RTTY: 500 Hz/–6 dB (500 Hz) 700 Hz/–60 dB AM: 6.0 kHz/–6 dB (6 kHz) 15 kHz/–60 dB FM: 12 kHz/–6 dB (15 kHz) 20 kHz/–60 dB * Variable between 50 Hz and 3.6 kHz.	SSB: 2.4 kHz/–6 dB (2.4 kHz) 3.4 kHz/–40 dB CW: 500 Hz/–6 dB (500 Hz) 700 Hz/–40 dB RTTY: 500 Hz/–6 dB (500 Hz) 800 Hz/–40 dB AM: 6.0 kHz/–6 dB (6 kHz) 10 kHz/–40 dB FM: 12 kHz/–6 dB (15 kHz) 22 kHz/–40 dB * Variable between 50 Hz and 3.6 kHz.	SSB: 2.4 kHz/–3 dB (2.4 kHz) 3.6 kHz/–60 dB CW: 500 Hz/–3 dB (500 Hz) 700 Hz/–60 dB RTTY: 500 Hz/–3 dB (500 Hz) 700 Hz/–60 dB AM: 6 kHz/–3 dB (6 kHz) 15 kHz/–60 dB FM: 12 kHz/–6 dB (15 kHz) 20 kHz/–60 dB DV (12.5 kHz spacing): –50 dB DD (300 kHz spacing): –40 dB
	Spurious and image rejection	More than 70 dB* * Except for ADC aliasing on 50 MHz band.	More than 70 dB* * Except for ADC aliasing on 50 MHz band.	144/430 MHz SSB/CW More than 70 dB AM/FM/DV More than 60 dB 1200 MHz SSB/CW/AM/FM/DV/DD More than 50 dB
	Audio output power	More than 2.0 W (8 Ω load)	More than 2.5 W (8 Ω load)	More than 2.0 W (8 Ω load)
	US Military Standards and IP Rating	–	–	–

		IC-905	IC-705	IC-7100
General	Frequency coverage <small>(Differs according to version)</small>	144, 430 MHz, 1.2 GHz (23 cm), 2.4 GHz (13 cm), 5.6 GHz (6 cm) bands plus 10 GHz (3 cm) bands (with option CX-10G)	Tx: 1.8, 3.5, 7, 10, 14, 18, 21, 24, 28, 50, 144, 430 MHz band Rx: 30 kHz–199.999 MHz, 400–470 MHz* ²	Tx: 1.8, 3.5, 7, 10, 14, 18, 21, 24, 28, 50, 70* ¹ , 144, 430 MHz bands Rx: 30 kHz–199.999 MHz, 400–470 MHz* ²
	Modes	SSB, CW, AM, FM, RTTY, DV, DD*, ATV* (*1200 MHz and above)	USB, LSB, CW, RTTY, DV, AM, FM, WFM* (*Rx only)	USB, LSB, CW, RTTY, DV, AM, FM, WFM* (*Rx only)
	Frequency stability	Less than ±65 ppb (Total deviation) GPS-Controlled Oscillator	Less than ± 0.5 ppm (–10°C to +60°C)	Less than ±0.5 ppm (0°C to +50°C @ 430 MHz)
	Maximum current drain	Less than 5.5 A (at 13.8 V DC)	3 A at 13.8 V DC (10 W output) 2.5 A at 7.4 V DC (5 W output)	22 A (HF/50/70 MHz), 16 A (144/430 MHz) at 13.8 V DC
	Antenna connector	Type-N (144 – 1200 MHz), SMA × 2 (2.4, 5.6 GHz)	BNC (One connector for all bands)	SO-239 × 2
	Dimensions (W × H × D; Projections are not included)	Controller unit 200 × 83.5 × 82 mm RF unit 172 × 87 × 210 mm, CX-10G 181 × 115 × 64 mm	200 × 83.5 × 82 mm	Main unit: 167 × 58 × 225 mm Controller: 165 × 64 × 78.5 mm
	Weight (approx.)	Controller 0.94 kg, RF unit 3.2 kg, CX-10G 1.3 kg	1.1 kg (including BP-307)	Main unit: 2.3 kg Controller: 500 g
Transmitter	Output power	SSB, CW, FM, RTTY, DV, DD* ³ , ATV* ³ : 144, 430 MHz, 1.2 GHz 10 W 2.4, 5.6 GHz 2 W 10 GHz (with CX-10G) 0.5 W typ. AM: 144, 430 MHz, 1.2 GHz 2.5 W 2.4, 5.6 GHz 0.5 W 10 GHz (with CX-10G) 0.125 W typ.	13.8 V DC SSB, CW, RTTY, FM, DV: 0.1–10 W AM: 0.025–2.5 W Using specified Icom's battery pack (7.4 V DC) SSB, CW, RTTY, FM, DV: 0.1–5 W AM: 0.025–1.25 W	SSB, CW, RTTY, FM, DV: 1.8–50 MHz 2–100 W 70/144 MHz 2–50 W 430 MHz 2–35 W AM: 1.8–50 MHz 1–30 W 70 MHz 1–15 W
	Sensitivity (typical) <small>Preamp ON SSB, CW, RTTY, AM: at 10dB S/N FM, WFM: at 12 dB SINAD DV: at 1 % BER</small>	SSB, CW: 144/430 MHz, 1.2/2.4 GHz 0.11 µV 5.6 GHz 0.15 µV 10 GHz (with CX-10G) 0.14 µV AM: 144/430 MHz, 1.2/2.4 GHz 1.0 µV 5.6 GHz 1.4 µV 10 GHz (with CX-10G) 1.1 µV FM: 144/430 MHz, 1.2/2.4 GHz 0.17 µV 5.6 GHz 0.25 µV 10 GHz (with CX-10G) 0.22 µV DV: 144/430 MHz, 1.2/2.4 GHz 0.35 µV 5.6 GHz 0.50 µV DD: 1.2/2.4 GHz 1.58 µV 5.6 GHz 2.23 µV	SSB, CW: 1.8–29.999 MHz 0.2 µV (2.4 kHz) 50–54 MHz 0.15 µV 144/430 MHz 0.11 µV AM: 0.5–1.799 MHz 13 µV (6 kHz) 1.8–29.999 MHz 2.0 µV 50–54 MHz 1.0 µV 144/430 MHz 1.0 µV FM: 28–29.7 MHz 0.5 µV (15 kHz) 50–54 MHz 0.25 µV 144/430 MHz 0.18 µV DV: 28–29.7 MHz 1 µV 50–54 MHz 0.63 µV 144/430 MHz 0.35 µV WFM: 76–108 MHz 0.71 µV	SSB, CW: 1.8–29.999 MHz 0.15 µV (2.4 kHz) 50–54 MHz 0.12 µV 144/430 MHz 0.11 µV AM: 0.5–1.8 MHz 13 µV (6 kHz) 1.8–29.999 MHz 2.0 µV 50–54 MHz 1.0 µV 144/430 MHz 1.0 µV FM: 28–29.7 MHz 0.5 µV (15 kHz) 50–54 MHz 0.25 µV 144/430 MHz 0.18 µV DV: 28–29.7 MHz 1 µV 50–54 MHz 0.63 µV 144/430 MHz 0.35 µV WFM: 76–108 MHz 10 µV
Receiver	Selectivity * Filter: SHARP	SSB: 2.4 kHz/–3 dB (2.4 kHz) 3.6 kHz/–60 dB CW: 500 Hz/–3 dB (500 Hz) 700 Hz/–60 dB RTTY: 500 Hz/–3dB (500 Hz) 700 Hz/–60 dB AM: 6.0 kHz/–3 dB (6 kHz) 15 kHz/–60 dB FM: 12 kHz/–6 dB (15 kHz) 20 kHz/–60 dB DV (12.5 kHz spacing): –50 dB DD (300 kHz spacing): –40 dB	SSB: 2.4 kHz/–6 dB (2.4 kHz) 3.4 kHz/–40 dB CW: 500 Hz/–6 dB (500 Hz) 700 Hz/–40 dB RTTY: 500 Hz/–6 dB (500 Hz) 800 Hz/–40 dB AM: 6.0 kHz/–6 dB (6 kHz) 10 kHz/–40 dB FM: 12 kHz/–6 dB (15 kHz) 22 kHz/–40 dB DV (12.5 kHz spacing): –50 dB	SSB: 2.4 kHz/–6 dB (2.4 kHz) 3.4 kHz/–40 dB CW: 500 Hz/–6 dB (500 Hz) 700 Hz/–60 dB RTTY: 500 Hz/–6 dB (500 Hz) 800 Hz/–40 dB AM: 6.0 kHz/–6 dB (6 kHz) 10 kHz/–40 dB FM: 12 kHz/–6 dB (15 kHz) 22 kHz/–40 dB DV (12.5 kHz spacing): –50 dB
	Spurious and image rejection	144/430 MHz SSB/CW More than 70 dB AM/FM/DV More than 60 dB 1.2/2.4/5.6 GHz SSB/CW/AM/FM/DV/DD More than 50 dB	More than 70 dB (HF/50 MHz)* More than 65 dB (144 MHz) More than 54 dB (430 MHz) * Except for ADC aliasing below 25 MHz. More than 50 dB at intermediate frequency in 25 – 30 MHz or 50 – 54 MHz.	More than 70 dB (HF/50/70 MHz) More than 65 dB (144/430 MHz) (Except 1/2 IF through on 50 MHz, IF through on 144 MHz)
	Audio output power <small>(at 10 % distortion)</small>	More than 530 mW (Internal SP, 12 Ω load) More than 200 mW (External SP, 8 Ω load)	More than 530 mW (Internal SP, 12 Ω load) More than 200 mW (External SP, 8 Ω load)	More than 2.0 W (8 Ω load)
US Military Standards and IP Rating	RF Unit IP55	MIL-STD-810-G	–	

*¹ Depending on version. *² Some frequency ranges are not guaranteed. *³ 1.2 GHz and above for DD and ATV mode.

SPECIFICATIONS FOR HANDHELDS, MOBILES & RECEIVERS

	ID-52E	ID-50E	IC-T10	ID-5100E	IC-2730E
Frequency coverage (Differs according to version)	Tx 144–146, 430–440 MHz Rx A band 108–174, 225–479 MHz* ¹ B band 137–174, 375–479 MHz* ¹ FM Broadcast 76–108 MHz	Tx 144–146, 430–440 MHz Rx A band 108–174, 375–479 MHz* ¹ B band 137–174, 375–479 MHz* ¹ FM Broadcast 76–108 MHz	Tx 144–146, 430–440 MHz* ¹ Rx 136–174, 400–479 MHz* ¹ FM Broadcast 76–108 MHz	Europe version : Tx 144–146, 430–440 MHz Rx 118–174, 375–550 MHz* ¹ Italia version : Tx 144–146, 430–434, 435–438 MHz Rx 118–136.991, 144–146, 430–434, 435–438 MHz* ²	Europe version : Tx 144–146, 430–440 MHz Rx 118–174, 375–550 MHz* ¹ Italia version : Tx 144–146, 430–434, 435–438 MHz Rx 118–136.991, 144–146, 430–434, 435–438 MHz* ²
Modes	DV, FM, FM-N, WFM (Rx only), AM (Rx only), AM-N (Rx only)	DV, FM, FM-N, WFM (Rx only), AM (Rx only), AM-N (Rx only)	FM, FM-N	DV, FM, FM-N, AM (Rx only), AM-N (Rx only)	FM, FM-N, AM (Rx only), AM-N (Rx only)
Max. current drain	2.5 A	2.5 A	2.5 A	13 A	13 A
Number of Memory channels	1054 (1000 regular, 50 scan edges and 4 call channels)	529 (500 regular, 25 scan edges and 4 call channels)	208 (200 memory channels, 2 call channel and 6 scan edges)	1054 (1000 regular, 50 scan edges and 4 call channels)	1052 (1000 regular, 50 scan edges and 2 call channels)
Dimensions (W x H x D; Projections are not included)	61.1 x 121.6 x 34.8 mm with BP-272	58.0 x 111.0 x 33 mm with BP-272	52.2 x 111.8 x 30.3 mm with BP-280	Main unit: 150 x 40 x 172.6 mm Controller: 182.2 x 81.5 x 24.7 mm	Main unit: 150 x 40 x 151 mm Controller: 150 x 50 x 27.2 mm
Weight (approx.)	330 g with antenna and BP-272	300 g with antenna and BP-272	278 g with BP-280 and antenna	Main unit: 1.3 kg Controller: 260 g	Main unit: 1.2 kg Controller: 140 g
Output power (typical values)	High: 5 W Mid: 2.5 W Low1: 1 W Low2: 0.5 W S-Low: 0.1 W	High: 5 W Mid: 2.5 W Low1: 1 W Low2: 0.5 W S-Low: 0.1 W	High: 5 W Mid: 2.5 W Low: 0.5 W	High: 50 W Mid: 15 W Low: 5 W (at 13.8 V DC)	High: 50 W Mid: 15 W Low: 5 W
Sensitivity (FM at 12 dB SINAD, DV at 1% BER, guaranteed range)	DV Less than 0.2 µV FM/FM-N Less than 0.18 µV (144, 430 MHz bands)	DV Less than 0.2 µV FM/FM-N Less than 0.18 µV (144, 430 MHz bands)	FM/FM-N Less than 0.18 µV	DV Less than 0.28 µV FM/FM-N Less than 0.18 µV (144, 430 MHz bands)	FM/FM-N Less than 0.18 µV (144, 430 MHz bands)
Audio output power (at 10% distortion)	More than 750 mW (Internal SP, 8 Ω load) More than 200 mW (External SP, 8 Ω load)	More than 750 mW (Internal SP, 8 Ω load) More than 200 mW (External SP, 8 Ω load)	1500 mW typ. (Internal SP, 8 Ω load) 450 mW typ. (External SP, 8 Ω load) 1500 mW typ. (HM-222HLWP, 8 Ω load)	More than 2.0 W (8 Ω load)	More than 2.0 W (8 Ω load)
MIL-STD and IP Rating	IPX7	IPX7	MIL-STD-810-G, IP67	MIL-STD-810-G	MIL-STD-810-G

*¹ Guaranteed range 144–146 and 430–440 MHz. *² Guaranteed range 144–146, 430–434 and 435–438 MHz.

All stated specifications are subject to change without notice or obligation.

	IC-R8600	IC-R6
Frequency coverage (Differs according to version)	0.01–3000 MHz* ³	0.1–1309.995 MHz
Mode	USB, LSB, CW, FSK, AM, FM, WFM, D-STAR (DV), P25, NXDN, dPMR, DCR, S-AM	FM, WFM, AM
Frequency stability	Less than ±0.5 ppm (at 25°C after warm up)	±1.0 ppm (at 25°C)
Maximum current drain	2.0 A	130 mA typical (at 3.0 V DC)* ⁴
Antenna connector	ANT1: Type-N (50 Ω), ANT2: SO-239 (50 Ω), ANT3: RCA (500 Ω)	SMA (50 Ω)
Dimensions (Projections are not included)	220 (W) x 90 (H) x 230 (D) mm	58 (W) x 86 (H) x 29.8 (D) mm
Weight (approx.)	4.3 kg	200 g with antenna and battery cells
Sensitivity SSB, CW, RTTY, AM, FSK: at 10 dB S/N FM, WFM: at 12 dB SINAD D-STAR, NXDN, dPMR, DCR: at 1% BER P25: at 5% BER	SSB/CW/FSK (Preamp ON, BW: SSB/FSK=2.4 kHz, CW=0.5 kHz): 0.1–1.799 MHz 0.5 µV 1.8–29.999 MHz 0.2 µV 30–1999.999 MHz 0.32 µV 2000–3000 MHz 0.4 µV AM (Preamp ON, BW=6 kHz): 0.1–1.799 MHz 6.3 µV 1.8–29.999 MHz 2.5 µV 30–3000 MHz 5.6 µV FM (Preamp ON, BW=15 kHz): 28–1999.999 MHz 0.5 µV 2000–3000 MHz 0.63 µV WFM (Preamp ON, BW=180 kHz): 30–1999.999 MHz 1.4 µV 2000–3000 MHz 1.8 µV D-STAR (DV)/NXDN/dPMR/DCR (Preamp ON): 28–1999.999 MHz 0.79 µV 2000–3000 MHz 1 µV P-25 (Preamp ON): 28–1999.999 MHz 0.56 µV 2000–3000 MHz 0.71 µV	FM (typical): 1.625–4.995 MHz 0.32 µV 5–29.995 MHz 0.25 µV 30–469.995 MHz 0.18 µV 470–832.995 MHz 0.32 µV 833–1029.995 MHz 0.28 µV 1030–1309.995 MHz 0.35 µV WFM (typical): 76–108 MHz 1.1 µV 175–221.995 MHz 1.1 µV 470–770 MHz 1.8 µV AM (typical): 0.495–4.995 MHz 1.3 µV 5–29.995 MHz 0.89 µV 118–136 MHz 0.63 µV 222–246.995 MHz 0.63 µV 247–329.995 MHz 0.79 µV
Sensitivity for RED Preamp ON SSB, AM, FM: at 12 dB SINAD (Only for amateur band. With CCITT filter ON)	SSB, FSK (Less than, BW=2.4 kHz) 0.1–2.999 MHz 10 dBµV emf 3–29.999 MHz 0 dBµV emf 30–3000 MHz –6 dBµV emf AM (Less than, BW=4 kHz) 0.1–2.999 MHz 16 dBµV emf 3–29.999 MHz 6 dBµV emf 30–3000 MHz 0 dBµV emf FM (Less than, BW=7 kHz) 3–29.999 MHz 0 dBµV emf 30–3000 MHz –6 dBµV emf	-
Selectivity	SSB/FSK (BW=2.4 KHz): More than 2.4 kHz/–3 dB Less than 3.6 kHz/–60 dB CW (BW=500 Hz): More than 500 Hz/–3 dB Less than 700 Hz/–60 dB AM (BW=6 kHz): More than 6.0 kHz/–3 dB Less than 15.0 kHz/–60 dB FM (BW=15 kHz): More than 12.0 kHz/–6 dB Less than 25.0 kHz/–60 dB WFM: More than 180 kHz/–6 dB	AM, FM: More than 12 kHz/–9 dB Less than 30 kHz/–60 dB WFM: More than 150 kHz/–6 dB
Audio output power (at 10% distortion)	More than 2.0 W (8 Ω load)	150 mW (Internal SP, 16 Ω load) 80 mW typical (External SP, 8 Ω load)
MIL-STD and IP Rating	MIL-STD-810-G	MIL-STD-810-F, IPX2

*³ Working range. *⁴ External SP, backlight OFF.

All stated specifications are subject to change without notice or obligation.

Global Wireless Communications Company

Icom Inc., founded over 50 years ago as an amateur radio manufacturing company is now a global wireless communications company that provides the world with the most comprehensive range of radio solutions for land, sea and air.



**Watch Our Brand Movie
on YouTube channel**



Icom and the Icom logo are registered trademarks of Icom Incorporated (Japan) in Japan, the United States, the United Kingdom, Germany, France, Spain, Russia, Australia, New Zealand and/or other countries. D-STAR (Digital Smart Technologies for Amateur Radio) is a digital radio protocol developed by JARL (Japan Amateur Radio League). Android and Google Play are registered trademarks or trademarks of Google LLC. The Bluetooth® word mark and logos are registered trademarks owned by Bluetooth SIG, Inc. and any use of such marks by Icom Inc. is under license. IOS is a trademark or registered trademark of Cisco in the U.S. and other countries and is used under license. App Store is a service mark of Apple Inc. Windows is a trademark of the Microsoft group of companies. USB Type-C is a trademark of USB Implementers Forum Inc. dPMR is a trademark of the dPMR MoU Association. NXDN is a trademark of Icom Incorporated and JVC KENWOOD Corporation. All other trademarks are the properties of their respective holders.

Icom Inc.

1-1-32, Kamiminami, Hirano-Ku, Osaka 547-0003, Japan Phone: +81 (06) 6793 5302 Fax: +81 (06) 6793 0013

www.icomjapan.com

Your local distributor/dealer:

ADVANTEC

Advantec Srl

Via Caduti per la Libertà, 13

10060 Pinasca TO - Italy

Tel. +39 0121326770

info@advantec.it - www.advantec.it